

LME-302-#

Single channel pyroelectric detector

Description:

single channel; TO39 housing; medium chip size; low Micro; JFET; voltage mode;

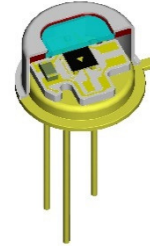

Housing:

TO39 2+1Pin
Bottom view

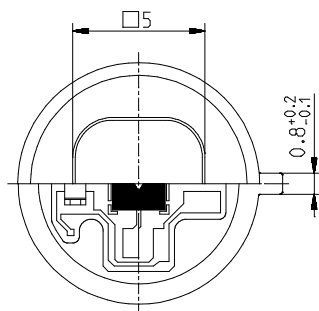
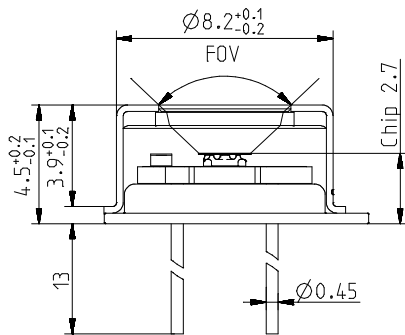
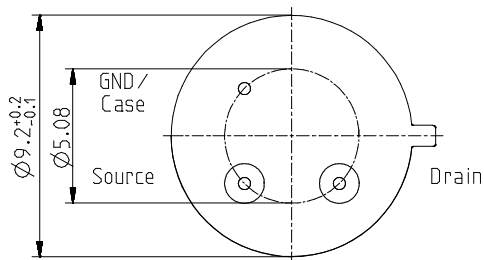

Top view

Pin Assignment:

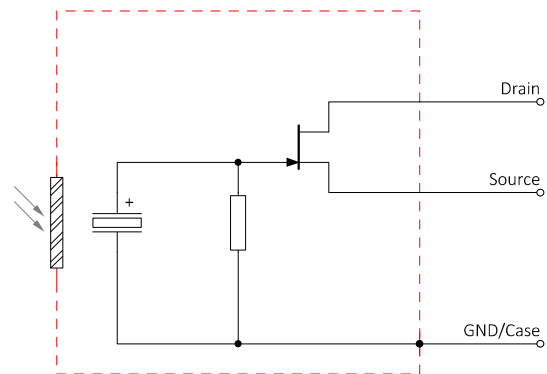

Frequency Response:

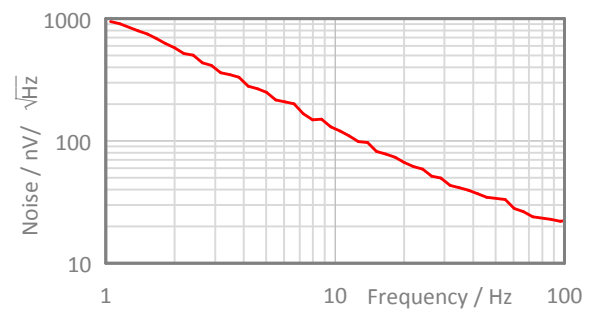
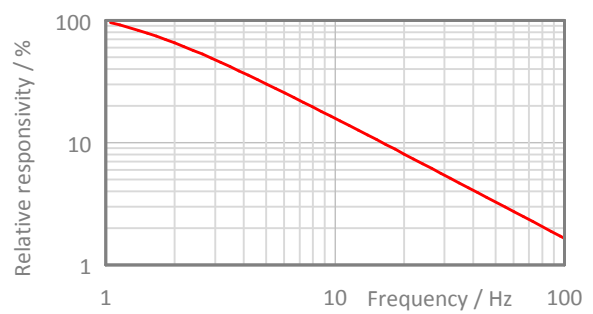

LME-302-#

Single channel pyroelectric detector

Test Circuit:

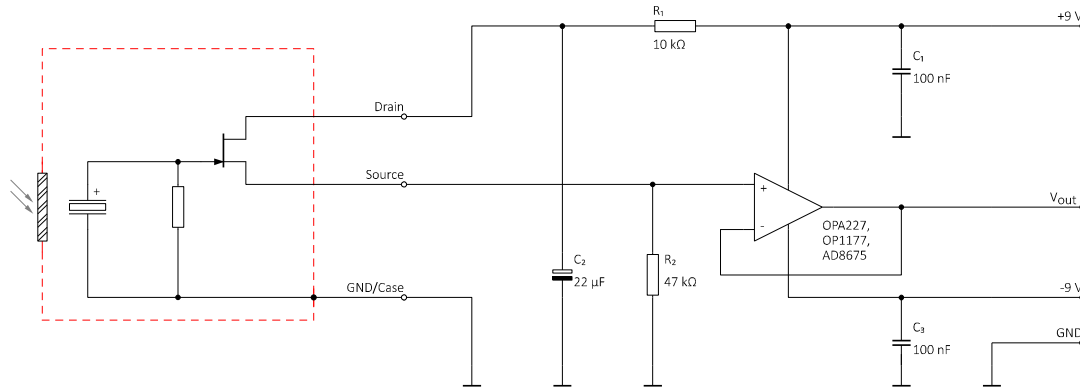

Parameters:

Aperture size	nom	□ 5.0 mm
Element size / type	nom	2.0 × 2.0 mm ² lithium-tantalate with black layer
Thermal time constant	typ	150 ms
Electrical time constant	typ	5 s
Polarity	nom	Positive signal by positive IR flux change
Voltage responsivity (rms) {500 K, 10 Hz, 25 °C, without filter/window}	min	340 V/W
Noise density (rms) {10 Hz, BW 1 Hz, 25 °C}	max	150 nV/√Hz
Detectivity {500 K, 10 Hz, 1 Hz, 25 °C, without filter/window}	typ	6.0E+08 cmVHz/W
Acceleration response {5 ... 200 Hz}	typ	2 μV/g; g = 9.81 m/s ²
Offset voltage {opt. Drain current = 10 ... 100 μA}	nom	0.4 ... 1.5 V
Drain source voltage	max	18 V
Operating / Storage temperature	nom	-40 ... +85 °C
IR filter		All InfraTec windows and filters are available (except KBr and CsI). Customized filters upon request.
Filter sizes	nom	Rectangular filters: (5.25 × 5.25) mm +0/-0.05 mm Circular filters: ø6.5 mm ±0.1 mm Standard thickness: 0.50 mm +0.2/-0.1 mm Thickness range 0.70 ... 1.10 mm on request
Field of View	min	CaF ₂ or BaF ₂ ; 0.4 mm thick: 80° Silicon substrate; 0.5 mm thick: 90°

InfraTec reserves the right to change these specifications at any time without notification.